

Long standby GPS Tracker

User Manual

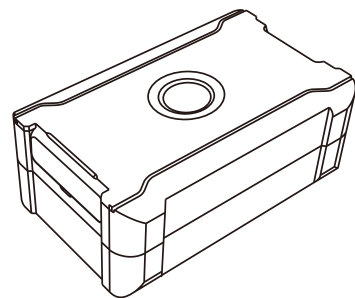

To ensure quick and correct usage, please read the instruction manual carefully before using it.

1 Product introduction

1.1 Specification

Item	Parameter
GSM Frequency	850/1900MHz
Supported location method	BDS/GPS/ LBS
Location Accuracy	≤10m
Light Alarm	Yes
Device Dimension	80x50x32mm
Battery Volume	5800mAh
Working Voltage	3.7V
Working Temperature	-25 to +85
Weight	227g

1.2 Device Dimension

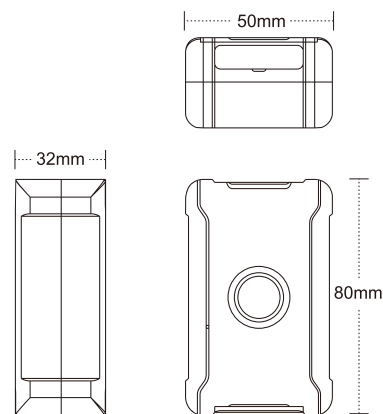

1.3 Accessories

Device	1
Charger	1
Cable Power	1
User Manual	1
Certificate Of Competency	1

1.4 Overview

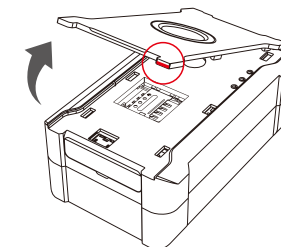

Find the notch and open the device casing

Open the SIM Card shell, insert the SIM Card with right direction as follows:

Attention: Make sure device shut down already, then insert SIM Card

LED Indicator

Power LED Indicator
GSM LED Indicator
Position LED Indicator

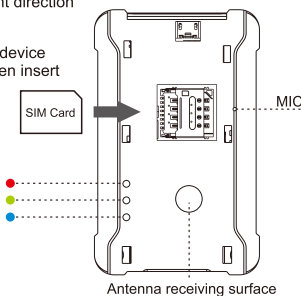

Strong Magnetic

Light Sensor

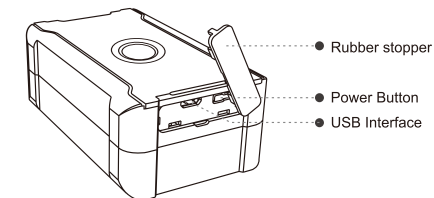
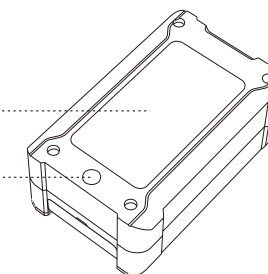

Power on and Power off

Power on: Long press the switch for more than 3 seconds, the main LED indicator quick flashing, which means working normally, then LED indicator extinguished, which means device enter sleep working mode.

Charging

Open the device silicone plug, connect to external power, red LED indicator long light means device charging, power LED slow flashing means device full charged.

2 Installation

2.1 Check Device

Check device shell and its accessories before installation

2.2 Install the device

A. Waterproof: Please choose somewhere is waterproof. Be careful to let device stay away from the air conditioning outlet to prevent condensate water from accumulating, which can avoid damaging the service life of the product.

B. Shakeproof: Do not install the device in the position with large vibration amplitude.

C. Tamper-proof: GPS Device should be away from electronic equipment to prevent signal interference.

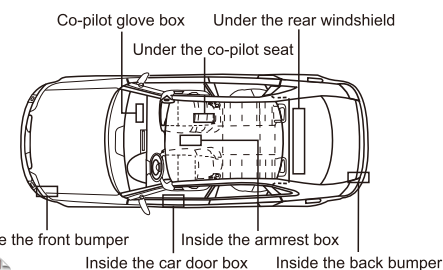

2.3 Installation Precautions

Device magnetic cannot touch somewhere high temperature, for example, car exhaust pipe, otherwise will make magnetic useless.

Please do the payment for the SIM Card per month or per year continuously, device cannot be used if overdue.

Device should be tested after the first installation.

The strong magnetic on the back of device cannot touch the hard disk digital products, which will cause damage to the hard disk.

If any questions, please contact us for help.

3 LED Indicator

LED Indicator	LED Indicator Status
Power LED Indicator (Red)	Long light: External power supply is charging
	Slowly blinking: Power supply or battery full charged
	Quickly blinking: Low backup battery
	No light: LED Indicator broken or sleeping mode
GSM LED Indicator (Yellow)	Quickly blinking: GSM initialization
	Slowly blinking: GSM received normal signal
	No light: Sleeping mode or no GSM internet
Location LED indicator (Blue)	Quickly blinking: Searching signal
	Slowly blinking: Signal normal
	No light: GPS in sleep mode or abnormal working

4 Device features list

Main features	Description
SOS set or delete	3 SOS numbers can be set or delete
Over-speed alarm	You will receive alarm if over-speed
Voice monitoring	The SOS number dials the phone number on the device and immediately enters the monitoring state. (note: this function can only be supported by voice card)
Geo-fence	You will receive alarm if GPS drive out in somewhere limited
Shock alarm	You will receive shock alarm when car shocked after turn on its defensive state.
Low battery alarm	You will receive low battery alarm once turn on low battery notification
Intelligent power saving mode	Unit set is seconds, default is 10 seconds to locate, which is the most accurate mode, G-SENSOR control gps working at the end, working 4 minutes each time.
Time interval working mode	The unit of time is minutes, and a range of 5-1440 minutes can be set for reporting
GPS/BDS	When no GPS or BDS signal is found, the base station is automatically started for positioning
Cut-wire alarm	Light detection oil dark to light to achieve the alarm dismantling
Free installation	Strong magnetic, free of installation

5 Access to platform

Platform (www.wanwaygps.com) • Android and IOS APP Trackway

There are two methods to login in the platform or app.

- Login by IMEI number (the 15 digits in the back of the device), password: the last 6 digits of imei number.
- Contact the supplier to create an account for you.

6 Precautions

- Device warranty not including the damage of human factor.
- Do not put device or its built-in battery in water or fire, do not bend or open the battery.
- Do not disassemble device, which may cause damage for device due to un-professional handling.

7 Solutions to common problems

Please contact to sales when you cannot handle problems.

Common problem	Fault description	Solutions
Poor signal	Some poor signal areas like basement, tunnels are not able to acquire GPS signal.	Move device to open sky areas.
Unable to boot	Device cannot acquire GPS signal if placed face down or above with metal material layer shielding	Please put in the correct direction or change the installation position
Cannot connect internet	Backup battery used up	Full charged before using
	SIM Card no data service	Please contact SIM Card operator check data service

Warranty policy

Special statement

This product is subject to any technical change without prior notice. Product appearance and color are subject to the real product.

Replacement policy

We can replace a new one for you if device not damaged by human factor.

Warranty Card

Customers Data

Customers Name		Telephone	
Address			
Model Type		IMEI number	
Purchase Data		Invoice No	
Company Address			

Please reserve the warranty card carefully

FCC Statement:

Any Changes or modifications not expressly approved by the party responsible for compliance could void the user's authority to operate the equipment.

This device complies with part 15 of the FCC Rules. Operation is subject to the following two conditions: (1) This device may not cause harmful interference, and (2) this device must accept any interference received, including interference that may cause undesired operation.

FCC Radiation Exposure Statement:

This equipment complies with FCC radiation exposure limits set forth for an uncontrolled environment. This equipment should be installed and operated with minimum distance 20cm between the radiator & your body.

Note: This equipment has been tested and found to comply with the limits for a Class B digital device, pursuant to part 15 of the FCC Rules. These limits are designed to provide reasonable protection against harmful interference in a residential installation. This equipment generates uses and can radiate radio frequency energy and, if not installed and used in accordance with the instructions, may cause harmful interference to radio communications. However, there is no guarantee that interference will not occur in a particular installation. If this equipment does cause harmful interference to radio or television reception, which can be determined by turning the equipment off and on, the user is encouraged to try to correct the interference by one or more of the following measures:

- Reorient or relocate the receiving antenna.
- Increase the separation between the equipment and receiver.
- Connect the equipment into an outlet on a circuit different from that to which the receiver is connected.
- Consult the dealer or an experienced radio/TV technician for help.